

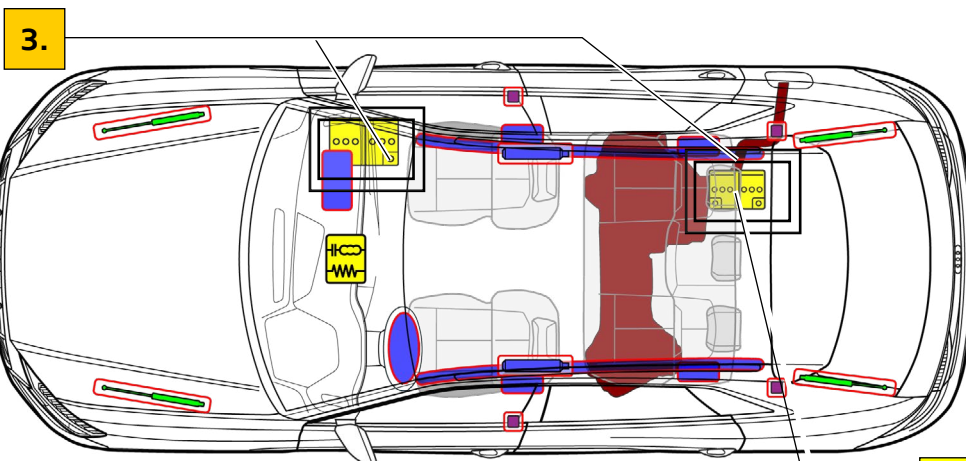

Audi Q8 / SQ8 / RSQ8

SUV, alates 2023

5-ukseline, 5 istet



48 V LIITIUMIOON
(valikuline)

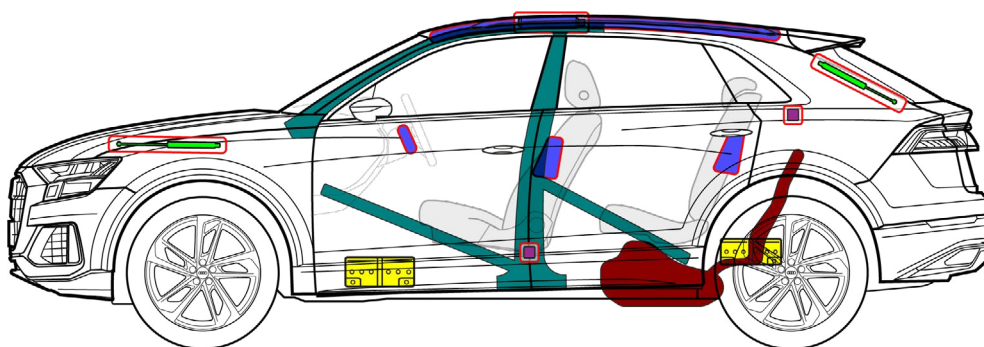

	Turvapadi		Gasigeneraator		Turvavööpinguti		SRSi juhtplokk		Aktiivne jalakäijate kaitsesüsteem
	Gaasvedrud/ eelpingutatud vedrud		Ülitugevad piirkonnad		Eriline tähelepanelikkus		Madalpingeaku		Bensiini- või diislikütuse paak



Audi Q8 / SQ8 / RSQ8

SUV, alates 2023

5-ukseline, 5 istet

1. Identifitseerimine/tuvastus

Kiri
Audi Q8 / SQ8 / RSQ8



Q8
Kiri
(kirjad on tühistatavad)

2. Fikseerimine/stabiliseerimine/tõstmine

Sõiduki fikseerimine

Vajutage parkimisnuppu „P“ ja rakendage seisupidur.



Tõstepunktid

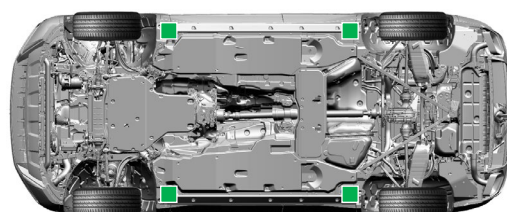

 sobivad tõstepunktid

3. Otseste ohtude vältimine / ohutuseeskirjad

Süüte väljalülitamine



Vajutage keskkonsoolis nuppu „Start-Engine-Stop“, ärge piduripedaali vajutage.

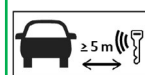

Viige raadiovõti, võtmekaart ja/või nutitelefon rakendus sõidukist võimalusel kaugemale kui 5 m.

12-voldise aku lahti ühendamine



Jalgaderuumis sõiduki paremal küljel



1. Eemaldage või tõstke üles jalamatid, vaibad.

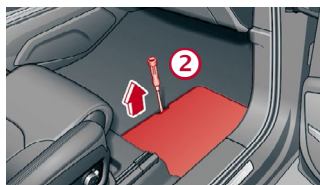

2. Tõstke akukate maha.



3. Ühendage esmalt lahti pardavõrguaku miinuspoolus (-), seejärel plusspoolus (+).



Audi Q8 / SQ8 / RSQ8

SUV, alates 2023

5-ukseline, 5 istet

48-voldise aku lahutamine

Avariide korral, mil turvapadi avaneb, inaktiveeritakse 48-voldine pardavõrk pärast turvapadja avanemise tuvastamist automaatselt.

Muudel juhtudel saab 48-voldise pardavõrgu inaktiveerida järgmiselt.



1. Võtke laadimisõrand pagasiruumist välja
2. Eemaldage varuratas või tööriistakomplekt (sõltuvalt variandist)
3. Eemaldage 48 V liitumioonaku kate, selleks eemaldage kruvi-keerajaga neli tihvti
4. Tõmmake sidepistik maha
5. Eemaldage poolusekate
6. Keerake miinus-pooluse (pruun/lilla kaabel) kruviühendus lahti

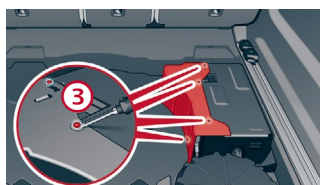
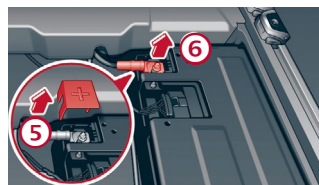
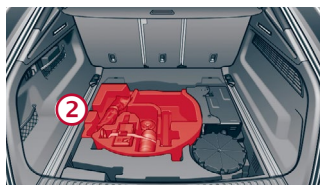
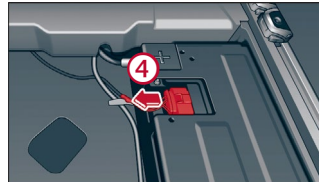
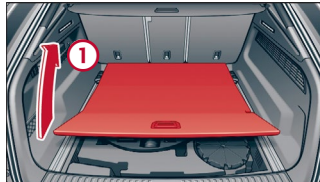

4. Juurdepääs reisijatele

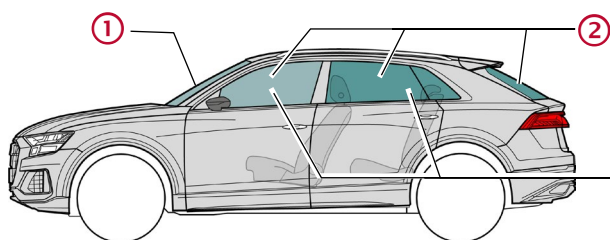

Klaasi tüübid:

- ① Komposiitklaasist turvaklaas
- ② Karastatud turvaklaas
- ③ Valikulised küljeklaasid Komposiitklaasist turvaklaas

5. Salvestatud energia / vedelikud / gaasid / tahked ained



Bensiin või diislikütus
max 90 l



12 V



48 V
Liitumioon

6. Tulekahju korral



**Liitumioonakud võivad ise süttida ja pärast tule kustutamist uuesti süttida!
Kandke vastavat kaitsevarustust!**

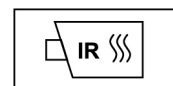



Audi Q8 / SQ8 / RSQ8

SUV, alates 2023

5-ukseline, 5 istet

7. Vee all

Pärast veest välja tõstmist laske veel välja voolata ja ühendage aku(de) klemmid lahti (vt peatükki 3). Kandke vastavat kaitsevarustust!

8. Pukseerimine/transportimine/hoiustamine



Liitumioonakud võivad ise süttida ja pärast tule kustutamist uuesti süttida!
Kandke vastavat kaitsevarustust!

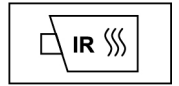

9. Oluline lisateave

Lisateave Audi päästejuhendis aadressil www.audi.com/rescue

10. Kasutatud piktogrammide selgitus

							
Tuleohtlik	Söövitav, nahka ärritav	Tervisele ohtlik	Keskkonno- ohtlik	Bensiini- mootoriga sõiduk	Diiselmootoriga sõiduk	Kustutada veega	Eemaldage nutivõti
							
Tehke pakiruum lukust lahti							